



Fixing Instructions

Cassius Vertical Radiator



Please unpack your delivery carefully and inspect the radiator and contents – any damages or shortages must be notified to your supplier **within 3 days of delivery** of your goods.

Specifications

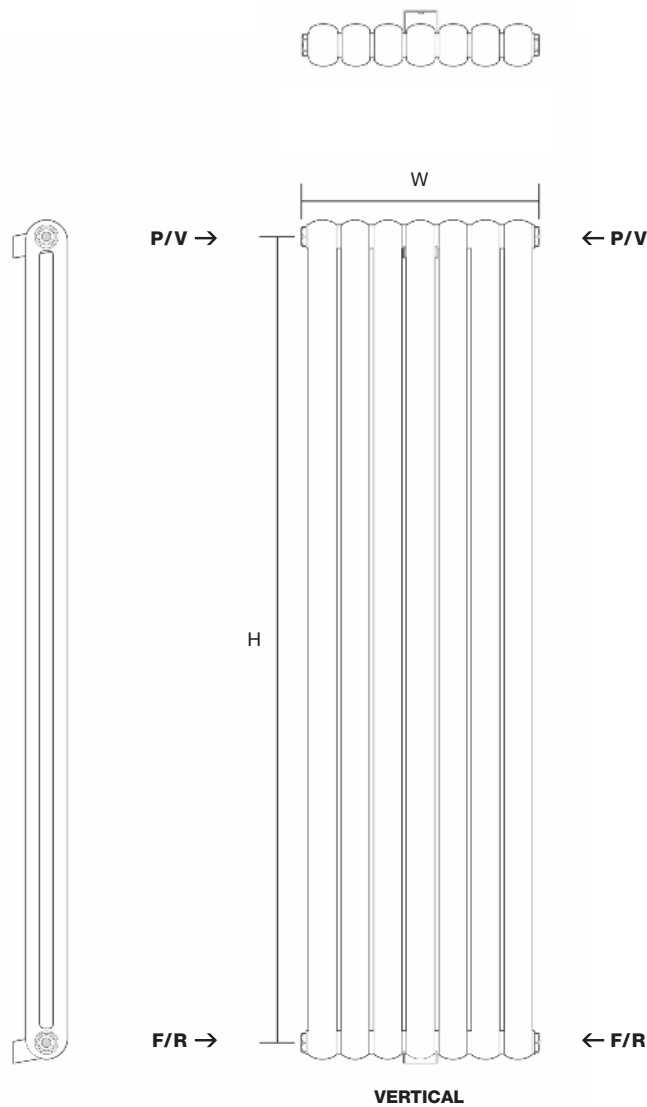

Technical Information

Standard connections: ½"

F = Flow **R** = Return

P = Plug **V** = Vent

Pipe centres:

Vertical = radiator width + valves

Wall to front face = 115mm

Wall to pipe centre = 70mm

Technical Specifications

Materials: Mild Steel

Connections: ½" Flow and Return

Test pressure: 8 Bar

Testing authority: EN442

Max operation pressure: 4 Bar

Max working temperature: 95c

These can be cleaned using a soft damp cloth with a non-abrasive cleaning product.



PLEASE NOTE: That in accordance with Part L1 2006 of the Building Regulations and BS7593:1992 code of practice for the treatment of hot water and central heating systems, we recommend flushing the heating system before installation of new radiators and then adding the correct quantity and type of inhibitor for use with the radiator and system to prevent corrosion. Damage caused to systems not protected by a suitable inhibitor will not be covered by the manufacturer warranty. It is the responsibility of the installer to ensure the correct use and suitability of the fixings provided. No liability for costs or damages arising from failure to do so can be accepted.

Content list & Tools required



Review instructions carefully before installation.
Installation should be completed by a suitably qualified person.
Please dispose of packaging in a responsible manner.

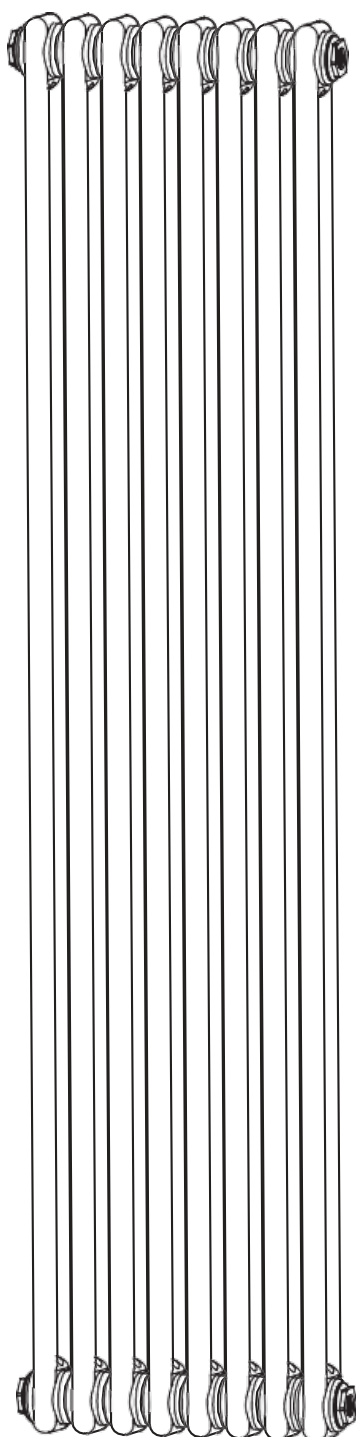

Contents list

Accessory for bars ≤ 22 (>22 bar)

Ref	Icon	Description	Qty
A		Spare Washer	1
B		Masonry Wall Plug	8 (12)
C		Screw	8 (12)
D		Air Vent	1
E		Blank Plug	1
F		Wall Bracket	4 (6)

Tools required

	Screwdriver
	Pencil
	Adjustable Wrench
	Rubber Hammer
	Glove
	Tape Measure
	PTFE Tape
	Spirit Level
	Electric Drill
	Clean Cloth



1. Follow installation instructions carefully to ensure unit is properly attached to the wall.
2. To avoid a possible fire hazard, it is essential unit is mounted in accordance with guidelines stated in the instruction.
3. Radiator is intended for indoor use only, do not place radiator inside a shower, steam room, or wherever unit would be exposed to water.
4. These radiators can be very heavy products it is recommended you consult a qualified person if you are unsure about the suitability of the wall they are to be mounted on to take the weight.

Technical Data

It should only be filled with water and at a temperature below 100°C(212°F). See table below for installation requirements. If the temperature exceeds 48°C (or 120°F), please install a warning sign near the product to avoid burning and scolding accidents.

Fill 3/4 Full: water only

Temperature: $0^{\circ}\text{C} < t \leq 100^{\circ}\text{C}$

Comments: If ambient temperature drops below 1°C, drain out the water to prevent freezing.

Important: Wipe the surface clean with a soft, damp cloth. Never use abrasive cleaners on this product as they will damage the surface.

Important Child Safety Note

Important: Please note that you are 100% legally responsible for your own child's safety at home. Once the radiator is installed, it can become a hazard for children. This radiator is not designed to support unreasonable extra weight, such as that of a child, and the radiator becomes hot during use. Due to this, we must stress that you should not allow children to climb/grab/play with the radiator or rails, as this can cause accident or injury for the child from heat, falling or the radiator being pulled off the wall.

Before Installation

- Observe all local plumbing and building codes.
- Shut off the main water supply.
- Read these instructions carefully to ensure proper installation.
- Check to make sure you have the following parts indicated below.

Installation Instructions

- A** Position the radiator in desired location check for level and mark four equal positions for the brackets.



Before Installation place a dust sheet on the floor to prevent losing any small parts

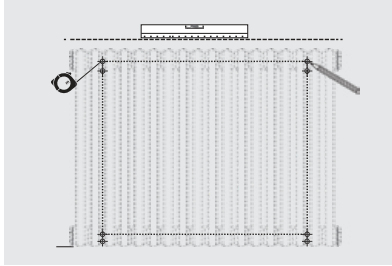

Allow enough room for the installation of valves and/or thermostatic controls

- B** Drill holes in wall and insert wall plugs. N.B For false or studded walls different fixings can be purchased from your local DIY store.

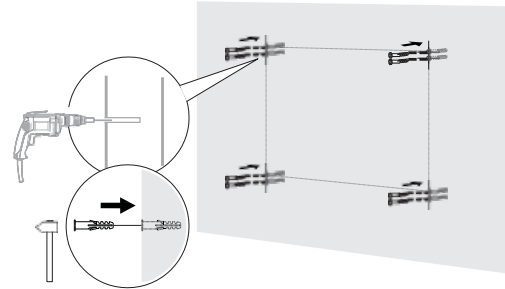

- C** Fix the wall brackets to the wall with screws provided and ensure a secure holding.

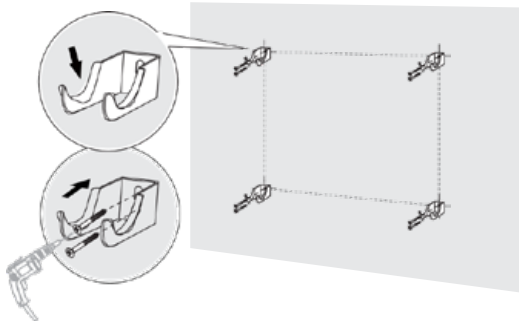

- D** Wrap PTFE tape around blanking plug and bleeder valve and screw into top of radiator tighten with a spanner.

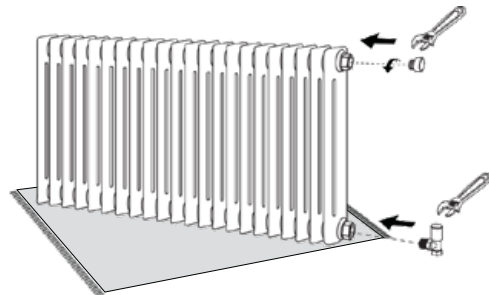

Apply PTFE tape to valves and screw into bottom of radiator tighten with a spanner.

- E** Rest radiator onto brackets and connect valves to household supply.

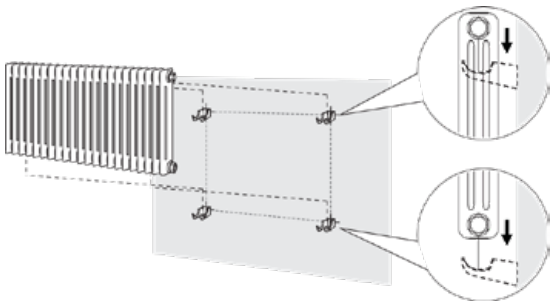

- F** Well Done

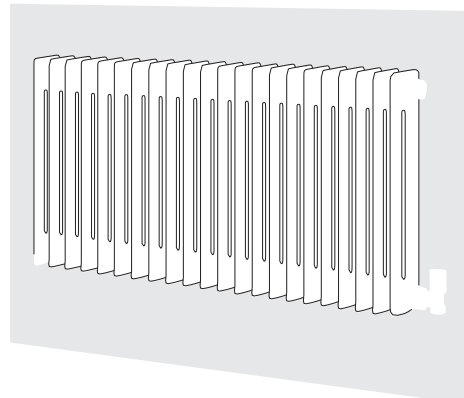

After Installation

Use a screwdriver to open the air vent, open the valve and let the water rush into the radiator.

Check all connection for leaks.

Once water overflows from the air vent, there is no air in the tube.

Use a screwdriver to close the air vent, turn on the valve and the radiator is ready for use.

Care & Cleaning

Radiators are made from steel with plating and should not be cleaned with corrosive or scouring cleaning agents.

Troubleshooting

When your radiator doesn't function, knowing basic radiator troubleshooting can save you from the stress and the hassles of a non-functioning radiator. Here is a guide to solve the most common problems associated with these radiators.

Problem	Cause	Action
Cold spots on the radiator unit	Water is not flowing through radiator properly	1. Check to make sure there is no trapped air inside the radiator. "Bleed" the radiator to release air. 2. Make sure the valve is fully open to allow water to run freely. Some radiators may need diverter for water to flow properly around the unit.
Leak on the radiator	Valve nut is loose Welding problem	Tighten the valve nut Replace radiator
Sound of whistling or water whooshing	Radiator was not properly balanced when it was installed	Re-install
Clanking sound	The radiator was installed in a space that doesn't allow for pipe expansion	Re-install

Terms and Conditions

You must immediately remove all packaging, inspect the goods and notify us of any damage to the goods within 3 days of delivery. We shall have no obligation to replace or repair damaged goods in the event of failure by the Buyer to comply with this provision. Radiators which are off an unacceptable standard or are damaged must not be installed. If any items is installed it will be treated as being as accepted as received.

Damaged goods being returned will only be collected from your delivery address, unless otherwise agreed in writing. Any other goods, which we accept back, are to be returned by you to our place of business at your expense.

Items will be accepted as a return which have not been installed or damaged after delivery. We do not accept liability for any damages sustained after delivery. Goods should be returned in their original packaging, provided such packaging and goods are undamaged.

We may issue a credit note for goods which we accept as returned.

We may agree to provide you with replacement goods prior to collecting or receiving back the goods to be returned (whether faulty, damaged or otherwise) but only on the condition that: the replacement goods are paid for in full and we reserve the right to re-invoice you in the event that the returned goods are found to be in a worse condition than when they were originally received by you or where such goods have not been received back to us within 3 months of the replacement goods being received by yourselves. A re-stocking charge of 30% will be applied to all non-faulty stock items that wish to be returned. Special order and non-stock products cannot be cancelled. Where cancellation or alteration of orders is accepted by us, you may be required to pay a restocking charge, to cover administrative costs and collection costs (if applicable); such charges to be determined by us. If the goods we deliver are faulty or damaged, we will meet the cost of the return, as long as the fault is reported to us within 3 working days.

The goods will be deemed to have been accepted when they have been delivered and we may not accept claims for any visible defects found after installation.

We accept no liability for any cost incurred relating to the cost of installation.

We shall not be liable for any plumber's costs, decorator's costs, transport costs, late penalties, or any other costs, as a direct or indirect result of (i) any defect in the goods (including but not limited to any manufacturing faults, such as leaks, that become apparent on or after installation) or (ii) late delivery of the goods.

GUARANTEES AND LIABILITIES – we are not the manufacturer of this product we will take all reasonable endeavours to make over to you the benefit of any warranty or guarantee given by the manufacturers. The item must have been fitted in accordance with British and or European standards as well as these fitting instructions.

