

1

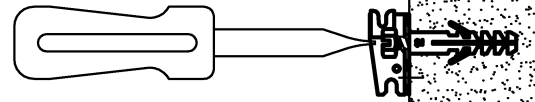

2

3

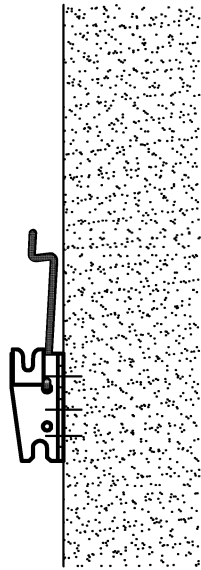
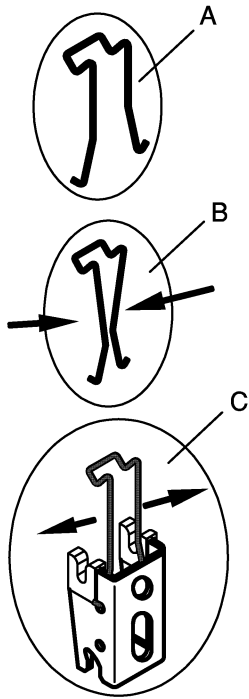

4

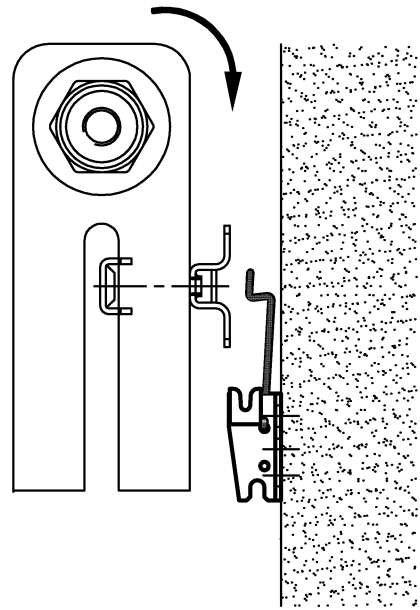

5

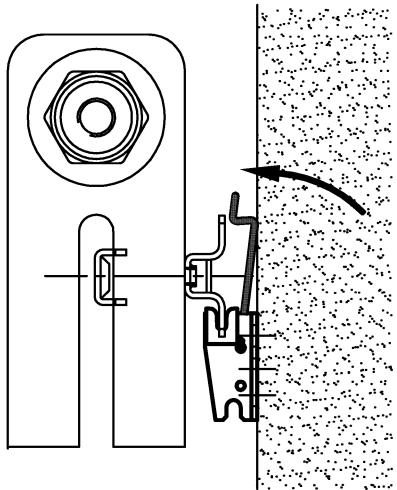

6

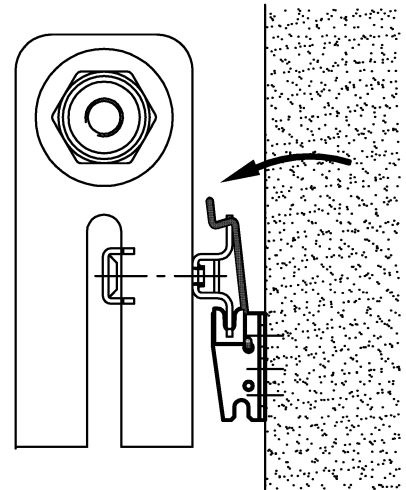

4 x BH	2 x	4 x CVD
6 x BH	2 x	6 x CVD
8 x BH	2 x	8 x CVD

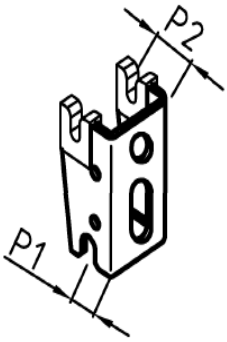
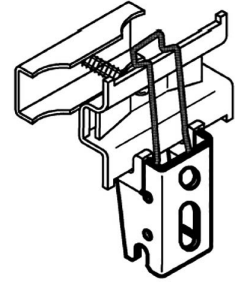
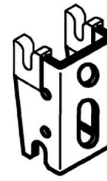
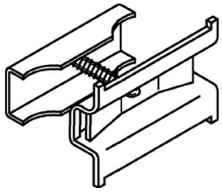

$D2 = WA + T$

CVD0	P1	P2	WA	T	62	100	136	173	210
				D					
	10	-	23	54	73	91	109	128	
	-	15	28	59	78	96	114	133	

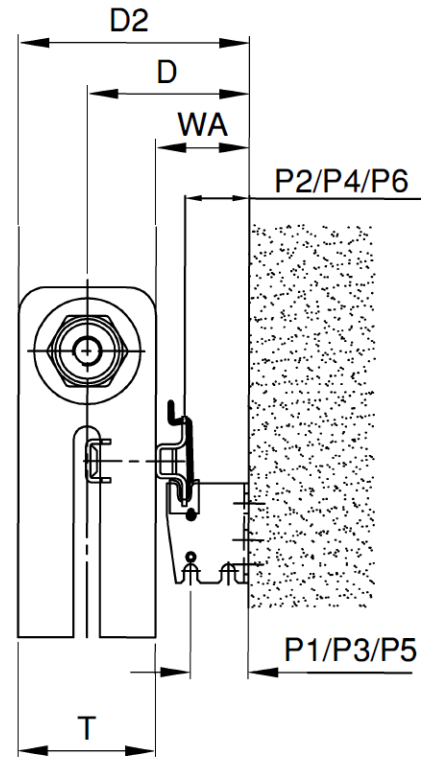

DQ

HEATING

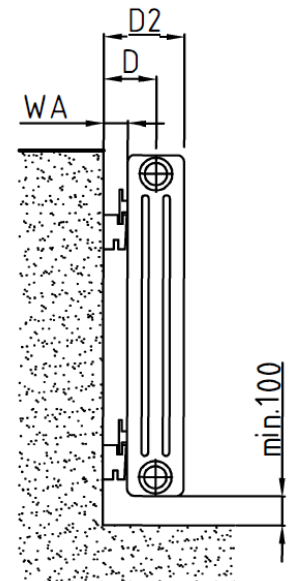
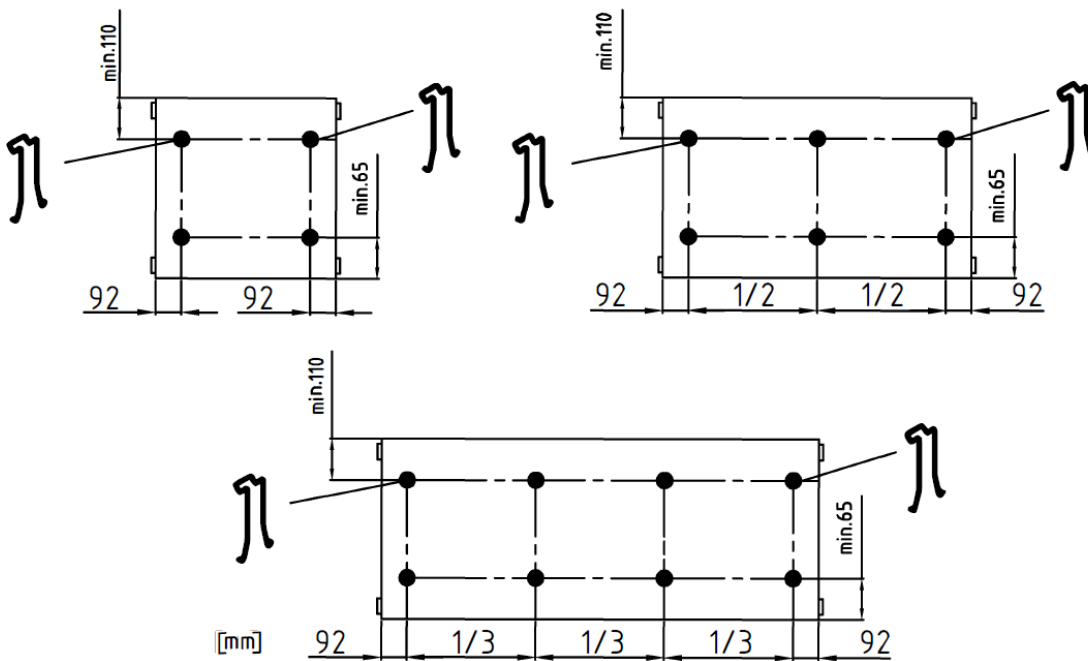

HOME



HEAT SYSTEM

HEATER
CONTROLLER
-
HORIZONTAL



TEMPERATURE
SENSOR/
REMOTE
CONTROLLER



GUIDE & USER MANUAL

HEATER CONTROLLER H+h | TEMPERATURE SENSOR



SAFETY:

1. **The heater should be installed by a qualified person.**
2. Bathroom radiators fitted with electric heaters should be fixed not less than 60 cm from a bath, shower or wash basin, and never above abath.
3. For the heater permanently connected (hard wire) there must be applied a cut-off device from the mains. Such a device must disconnect the heater from the supply mains in 2 poles, with contact separation of at least 3 mm.
4. This appliance can be used by children aged from 8 years and above and persons with reduced physical, sensory or mental capabilities or lack of experience and knowledge if they have been given supervision or instruction concerning use of the appliance in a safe way and understand the hazards involved
5. Children shall not play with the appliance. Cleaning and user maintenance shall not be made by children without supervision.
6. **The heater MUST BE DISCONNECTED before cleaning the casing. AVOID SOAKING THE CASING.**
7. One radiator valve must always be open when a heater is in use (liquid thermal expansion).

CAUTION: To avoid the risk of fire or electric shock the heater should be protected from water spray or flooding. This appliance is not intended for use by persons (including children) of limited physical, sensory or mental abilities, or persons inexperienced or not familiar with the appliance, unless supervised or instructed on the appliance use by persons responsible for their safety. Particular attention should be paid to children, to preclude playing with the appliance by them. Exclamation mark on triangular field signals:  **information important for the user.**

CAUTION: electric shock hazard!, lightning mark ended with arrow on triangular field 

CAUTION: in order to reduce electric shock hazard, do not remove the casing (nor its rear cover). There are no user-serviceable parts inside the appliance; the product must be returned to the manufacturer for repair via the distributor who sold the product.

GUARANTEE TERMS:

Guarantee is granted by manufacturer for 24 months period starting from date of sale, but no longer than 36 months from date of the heater manufacture. Defects revealed within this period, resulting from a fault of manufacturer will be repaired free of charge or the item replaced with new, equivalent one. Term of complaints' investigation up to 14 (fourteen) days from date of submission to the manufacturer.

Guarantee does not cover:

1. Using of product in a manner noncompliant with attached instructions.
2. Any visible damage to the heating element or controller due to improper use. Damaging of manufacturer's seals makes the guarantee null and void.

In the event that Heatpol are unable to repair or replace this product we reserve the right to refund the purchase price as an alternative.

GUARANTEE CARD

Serial No.:

Date of sale:

Stamp of retail outlet, signature of seller

MADE IN EU

Caution: The guarantee card should be legibly filled in retail outlet. Any corrections on the guarantee card will invalidate the guarantee. Guarantee card valid only with proof of purchase.

USER MANUAL: Heating element + Heater controller (horizontal) H+h

1

Kit content

Side connection

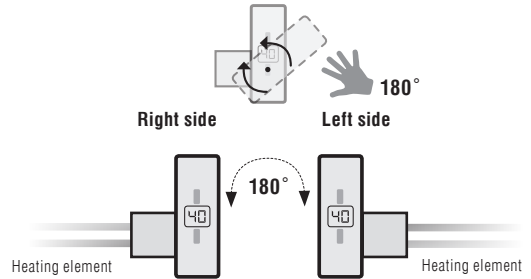
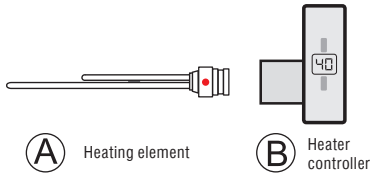

2

Preparing the temperature sensor

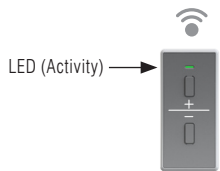

To activate temperature sensor for the first time, press the pairing button

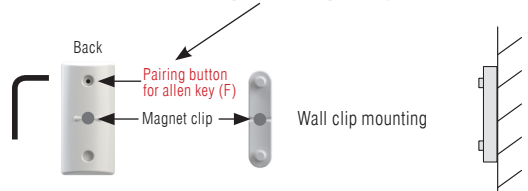

3

Locate suitable place to mount temperature sensor

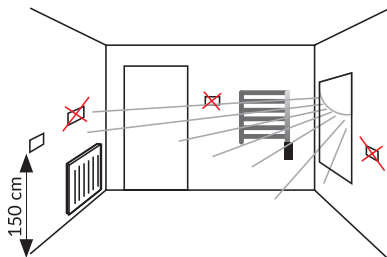

Do not place the temperature sensor:

- over the radiators
- next to doors
- in sunny places

USER MANUAL: Heating element + Heater controller (horizontal) H+h

Mounting in radiators: Central heating system

Electric radiators

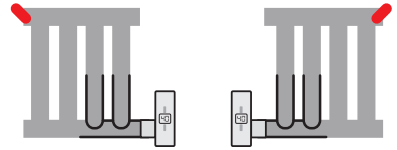
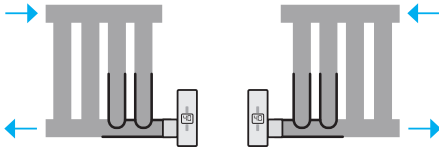

The electric heater must have a safety valve

Installation details

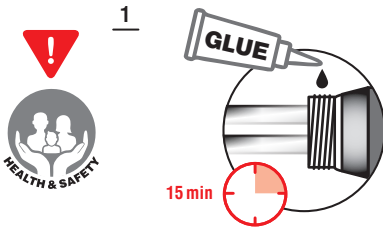

GLUE

Before you apply the heating element, spread the Loctite glue (**included in the set**) on the middle of the thread circumference.

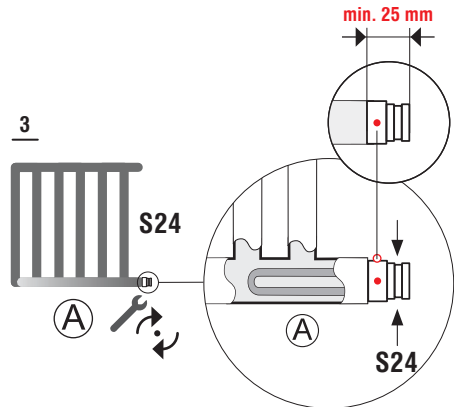
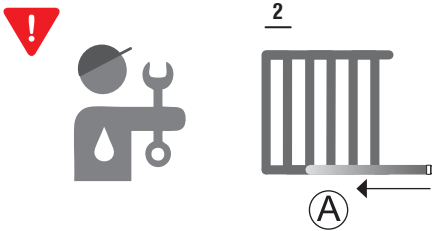

Do not play in yet

Line up dot at front

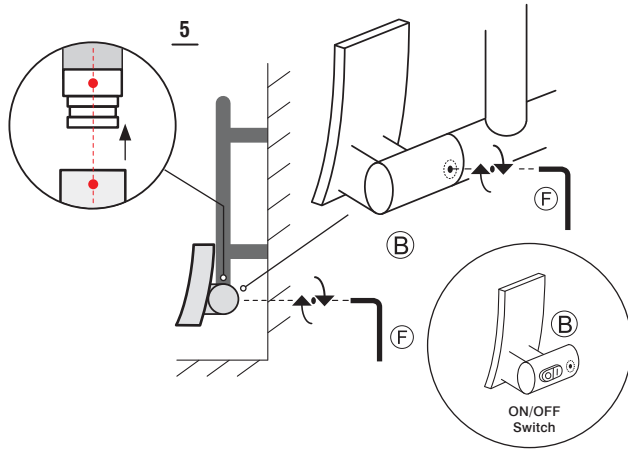
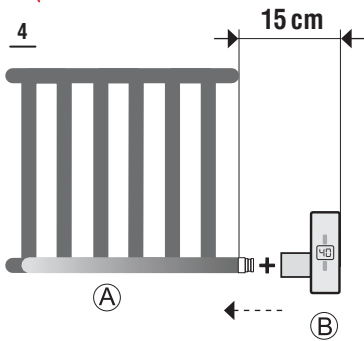

Electric radiators

Central heating system

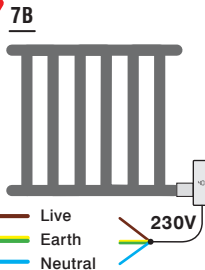
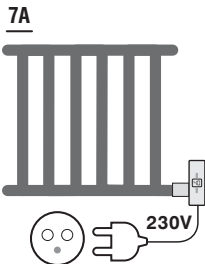
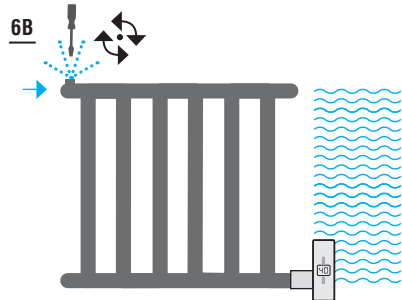
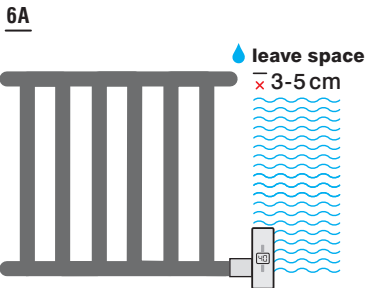

For the heater permanently connected (hard wire) there must be applied a cut-off device from the mains. Such a device must disconnect the heater from the supply mains in 2 poles, with contact separation of at least 3 mm from the main supply

1 Heater controller



When the heater is connected to the mains properly, the red light will flash on the controller display

2 The heater is ready for WiFi configuration

3 Go to supla.org and create a free supla account and follow the attached instructions.



DOWNLOAD THE APP

SUPLA.ORG



System requirements ANDROID 3.1/IOS 8.2 or the latest version

**Install the application on your devices.
The app will guide you through the individual installation steps.**



USER MANUAL: ERRORS

ATTENTION: Signalling improper installation or improper use:

- E1 Lack of water (or wrong choice of heating element to the heater)
- E2 Damaged heating element (or no power circuit)
- E3 No communication to the remote controller if paired



DO NOT DISCONNECT! controller from heating element, when connected to the power supply

ATTENTION:

The temperature sensor can be used as a remote controller instead of your Smartphone

1

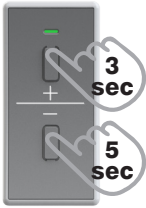

Run the controller

Hold upper button for 3 seconds

Switch off the controller

Hold lower button for 5 seconds

2

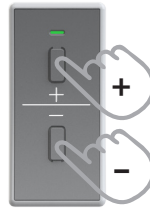

30°C - 65°C

Select temperature

40°C

Standard heating temperature

3

TURBO mode activation



TURBO mode activation - max heating temperature

Hold button for 3 seconds

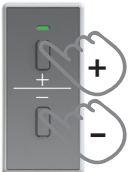

b1-b2-b3 Max heating temperature, **selection for 1/2/3 hours**

b0 Off selection

USER MANUAL:

NEW TEMPERATURE SENSOR/REMOTE CONTROLLER PAIRING

When you buy a new heating element with a remote controller it will already be paired. You do not need to pair it again.

In case you purchase a new temperature sensor/remote controller – you need to pair it:

Prepare remote controller + allen key for use

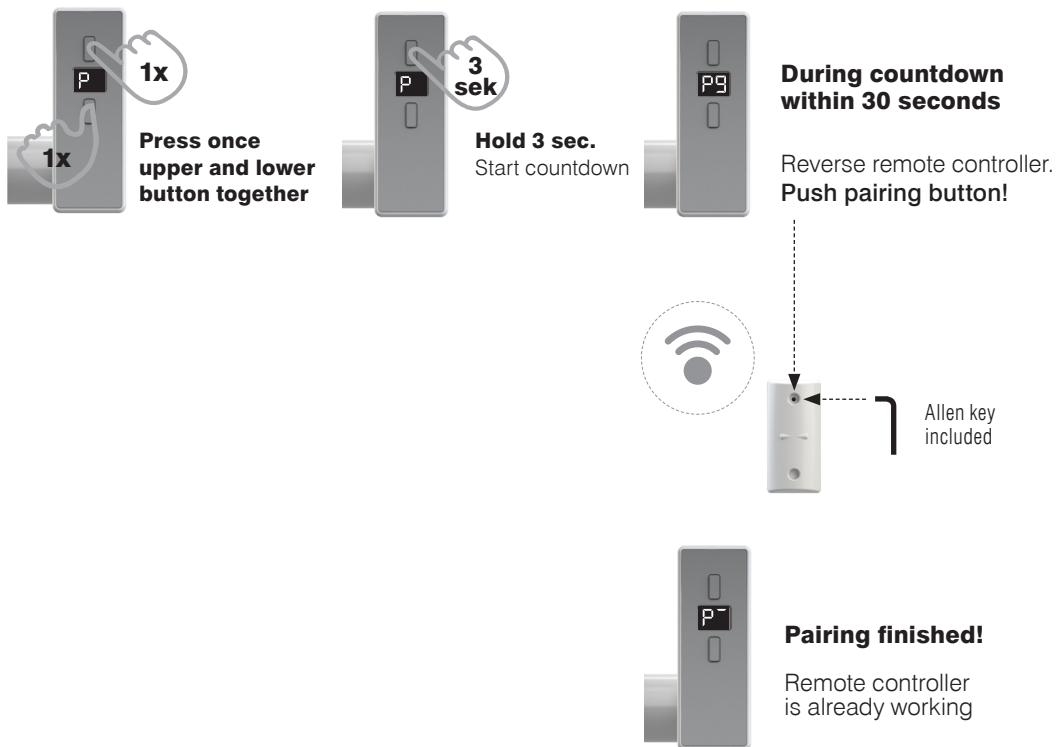

A short guide for using the SUPLA App.

Once the device has been successfully configured the added heater will appear on the **main screen** of the Application.

The green dot on the right side shows that the App. can control the heater.





With your finger, slide the selected heater to the left and the main settings screen will open.

The main settings



The first temperature (19.20°) - is measured with the remote / temp. sensor (H+R). This is the actual room temperature. The second (12°) is the temperature set for the room.

Touching the buttons listed below it makes possible to change :

- + button - increase the temperature setting for the room
- button - decrease the temperature setting for the room
- ON / OFF** button - Operating or standby mode of the heater
- MANUAL** - standard operating with + / - buttons on the right side of the screen
- ECO** - decreasing the temperature preset in **MANUAL** mode by up to 5 deg.
- TURBO** - sets the heater to the max. heating temperature. Selection for 1 / 2 / 3 hours
- AUTO** - operating under **weekly/daily** program – the schedule is opened by the “clock” button on the upper bar. (described in the next pages) In the **AUTO** mode “Pd” is displayed on the heater controller .
-  - opens the schedule for **AUTO** mode (to view or change the settings)
-  - opens the menu of temperature settings

Touching  icon on the upper bar switches over from any screen to the main screen.

AUTO mode



MANUAL mode

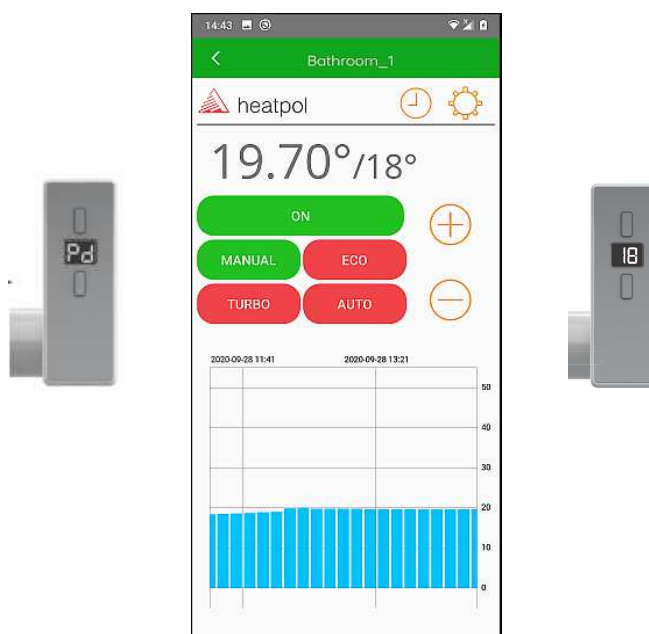

Touching  opens the menu of temperature settings, which allows to set :

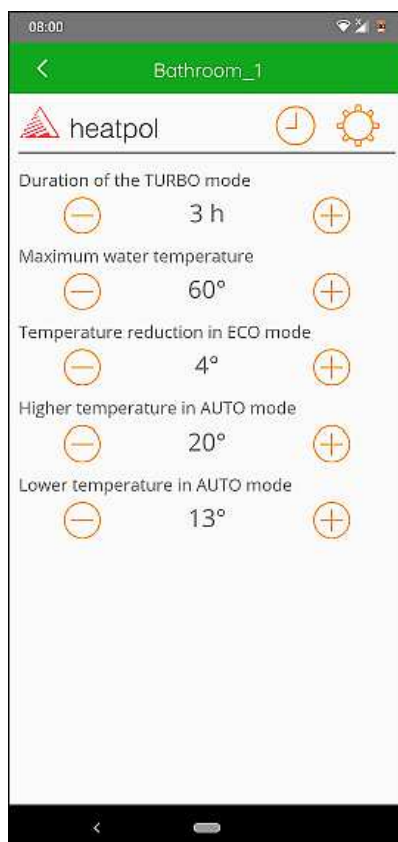

Change the duration of TURBO mode (1 / 2 / 3 hours)

The max. water temperature of the radiator
(from 30 to 70 deg. C)

Temperature reduction in ECO mode (from 1 to 5 deg.)
(Concerns the temperatures preset for MANUAL operating)

The “Higher” temperature preset for AUTO mode
(from 10 to 30 deg. C)

The ”Lower” temperature preset for AUTO mode
(from 10 to 30 deg. C)

NOTICE: the “Lower” temperature must be at least 1 degree below the “Higher” one.

Touching  again switches over to the main settings screen.

Touching  opens the schedule of AUTO mode.

An example of the schedule of AUTO mode (factory settings)



The schedule can be changed by shifting with ones finger over the screen.

The values of the temperatures are shown on the bottom of the screen. (preset in the temperature settings menu – the previous page)

Touching  again switches over to the main settings screen.

Troubleshooting :

If a heater in the App. is shown as disconnected – the red dot by the heater on the main screen (please look at the first page) - restart the corresponding WiFi router. It happens sometimes whilst using popular (usually low quality) routers.

Please assure that the router has enough numbers of channels for new WiFi devices.

If so, please switch OFF the router for a few minutes and then switch it ON again.

The lost heater should appear as connected again.

The lost communication has no influence on heater's operating. The heater itself will work all the time under previously set program.

HEAT-POL
10.2020_v1

TERMS AND CONDITIONS

You must immediately remove all packaging, inspect the goods and notify us of any damage to the goods within 3 days of delivery. We shall have no obligation to replace or repair damaged goods in the event of failure by the Buyer to comply with this provision. Radiators which are off an unacceptable standard or are damaged must not be installed. If any items is installed it will be treated as being as accepted as received.

Damaged goods being returned will only be collected from your delivery address, unless otherwise agreed in writing. Any other goods, which we accept back, are to be returned by you to our place of business at your expense.

Items will be accepted as a return which have not been installed or damaged after delivery. We do not accept liability for any damages sustained after delivery. Goods should be returned in their original packaging, provided such packaging and goods are undamaged.

We may issue a credit note for goods which we accept as returned.

We may agree to provide you with replacement goods prior to collecting or receiving back the goods to be returned (whether faulty, damaged or otherwise) but only on the condition that: the replacement goods are paid for in full and we reserve the right to re-invoice you in the event that the returned goods are found to be in a worse condition than when they were originally received by you or where such goods have not been received back to us within 3 months of the replacement goods being received by yourselves. A re-stocking charge of 30% will be applied to all non-faulty stock items that wish to be returned. Special order and non-stock products cannot be cancelled. Where cancellation or alteration of orders is accepted by us, you may be required to pay a restocking charge, to cover administrative costs and collection costs (if applicable); such charges to be determined by us. If the goods we deliver are faulty or damaged, we will meet the cost of the return, as long as the fault is reported to us within 3 working days.

The goods will be deemed to have been accepted when they have been delivered and we may not accept claims for any visible defects found after installation.

We accept no liability for any cost incurred relating to the cost of installation.

We shall not be liable for any plumber's costs, decorator's costs, transport costs, late penalties, or any other costs, as a direct or indirect result of (i) any defect in the goods (including but not limited to any manufacturing faults, such as leaks, that become apparent on or after installation) or (ii) late delivery of the goods.

GUARANTEES AND LIABILITIES – we are not the manufacturer of this product we will take all reasonable endeavours to make over to you the benefit of any warranty or guarantee given by the manufacturers. The item must have been fitted in accordance with British and or European standards as well as these fitting instructions.

PLEASE NOTE: That in accordance with Part L1 2006 of the Building Regulations and BS7593:1992 code of practice for the treatment of hot water and central heating systems, we recommend flushing the heating system before installation of new radiators and then adding the correct quantity and type of inhibitor for use with the radiator and system to prevent corrosion. Damage caused to systems not protected by a suitable inhibitor will not be covered by the manufacturer warranty. It is the responsibility of the installer to ensure the correct use and suitability of the fixings provided. No liability for costs or damages arising from failure to do so can be accepted.