



Delta Radiator Fixing Instructions

Please unpack your delivery carefully and inspect the radiator and contents – any damages or shortages must be notified to your supplier within 3 days of delivery of your goods.

SPECIFICATION FOR DELTA RADIATOR

TECHNICAL INFORMATION

STANDARD F = Flow P = Plug
 CONNECTIONS 1/2" R = Return V = Vent

PIPE CENTRES

Vertical = radiator width + valves
 Horizontal = radiator width - 50mm

Wall to front face = 60-70mm
 Wall to pipe centre = 35-45mm

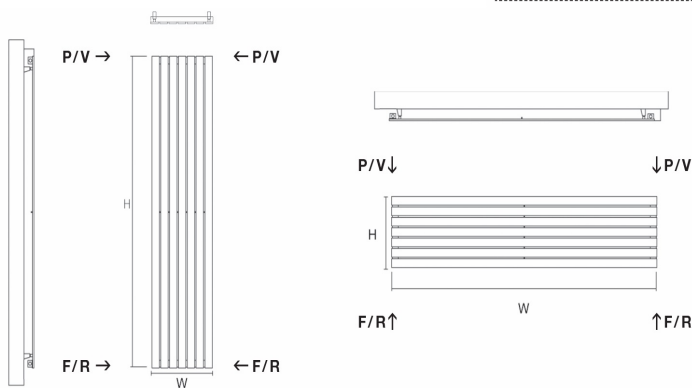

VERTICAL

HORIZONTAL

Technical Specifications

Materials	Stainless Steel
Connections	½" Flow and Return
Test Pressure	7 Bar
Testing Authority	EN442
Max operation pressure	4 Bar
Max working temperature	95c
These can be cleaned using a soft damp cloth with a non-abrasive cleaning product.	

PLEASE NOTE: That in accordance with Part L1 2006 of the Building Regulations and BS7593:1992 code of practice for the treatment of hot water and central heating systems, we recommend flushing the heating system before installation of new radiators and then adding the correct quantity and type of inhibitor for use with the radiator and system to prevent corrosion. Damage caused to systems not protected by a suitable inhibitor will not be covered by the manufacturer warranty. It is the responsibility of the installer to ensure the correct use and suitability of the fixings provided. No liability for costs or damages arising from failure to do so can be accepted.

USER MANUAL

for steel & stainless steel radiators

 **CAUTION:** To avoid overheating, do not cover the heating appliance.

 **CAUTION:** Hot surface.

THESE INSTRUCTIONS SHOULD BE READ CAREFULLY, AND RETAINED FOR FUTURE REFERENCE

DO NOT CONNECT THE RADIATOR TO NETWORK BEFORE HAVING READ AND UNDERSTAND THE FOLLOWING INSTRUCTIONS.

Radiator must be installed only by expert technicians and installation must be compliant with all applicable rules, and national safety regulations and laws in force in the country where the product is installed.

CAUTION - Some parts of this product can become very hot and cause burns. Particular attention has to be given where children and afflicted people are present.

During operation the radiator surface will get hot, however momentary contact with any part of it should not cause any injury.

In case the radiator is used in a public place, a warning should be placed next to it advising the hot surface.

CARE AND MAINTENANCE

Radiators are designed to be used under below circumstances;

- Radiators are heavy items and should be securely fastened to the wall. In all cases, it is strongly recommended that a suitably qualified professional carries out the installation. Specific care should be taken into consideration, including the fixing method used to secure the radiator to the wall, the type and the condition of the wall itself, and any additional potential forces or weights, prior to finalising installation.
- The wall plugs supplied with your radiator may not be suitable for your wall type. The appropriate wall plugs should be choosed by your installer.
- The product is reliable for maximum working pressure of 4 bar. DO NOT use the product above these maximum pressure limits.
- Before installing the radiator, heating system should be properly flushed and filled in order to remove debris, sludge and clean solid particles and chemical residues, which may cause corrosion and damage the system.

- When connecting pipes of various materials, their difference in electrode potential may cause galvanic corrosion and serious damage of pipes, valves and other equipment in the system. To avoid galvanic corrosion, it is highly recommended to use the same materials, or materials with similar electric potential, throughout loop.

- When the air is trapped within the radiator, it may cause inefficient warming. Purge plug should be loosened with a screwdriver to release the air. When the water starts to come out, the purge plug must be retightened.

- Do not empty the water in your radiators throughout summer or during a renovation when they are not in use for a long period. In this case turn of the inlet and outlet valves so that the water does not drain. If radiators are left dry for a long time corrosion can occur.

- Ph of the water used in the systems shall be between 8,5 and 10,5.

- To clean the product, use a slightly wetted piece of cloth. DO NOT use harsh chemicals, cleaning solvents, bleaches, strong detergents or especially those containing hydrochloric acid.

- Although there is no direct contact, usage of cleaning solvents, chemicals (strong acids) or bleaches in the same area with radiators may cause corrosion by the evaporation of these chemicals to air and condensation back to radiator surface. This results in damaging the passive film layer on stainless steel. Guarantee is not valid for such cases.

- The water in the system should not contain substances such as chlorine and halogen salts. Halogen salts and chlorine can cause corrosion in your radiator.

- Many water conditioning materials contain chlorinated hydrocarbons. The use of chlorinated hydrocarbons may harm to your radiator.

- Artificially softened water shall not be used in the system.

- Water from a thermal source should not be used directly in the heating system as heat transfer fluid.

- Radiators are designed to operate between 0 ° and 95 °. DO NOT use in open air environments.

- Radiators should be stored in dry, moisture-free, indoor and in chemical vapour free environments.

- Radiator and towel rack are for hanging and drying towel, do not use out of purpose. Do not hold onto, get support or climb on it. Do not extend the usage area of the hanger with additional apparatus.

- Never wash the product with water. Clean only with a wetted piece of cloth.

- Do not remove or loosen the towel holder fixing screws in products with towel holder.

GUARANTEE

- Guarantee conditions comply with the directive 1999/44/EC of the European Parliament and of the Council of 25 May 1999 on certain aspects of the sale of consumer goods and associated guarantees.

- Guarantee conditions do not apply in below explained conditions:

- Non-compliance with the operating instructions given by the manufacturer in the "care and maintenance" sections of this document during the use of the product,

- Modification or repair of the product by parties other than the manufacturer,

- Damaged caused intentionally, by negligence or by accident during transportation, installation or at any stage of the product's life cycle.

- Producer offers 5 years of guarantee for Carbon Steel radiators and 10 years of guarantee for Stainless Steel radiators when they are installed in Closed Systems*.

- In Open Systems** while guarantee conditions do not apply to Carbon Steel radiators, Stainless Steel radiators are under 5 years of producer guarantee.

- In Sanitary Hotwater Systems*** 2 years of producer guarantee is only valid for radiators which are produced from 316 Grade (EN1.4401) Stainless Steel. Guarantee conditions apply neither to Carbon Steel nor to 304 Grade (EN1.4301) Stainless Steel radiators that are installed in Sanitary Hotwater System.

* **CLOSED HEATING SYSTEM:** It is a system that water circulates in a closed loop water installation (including the radiator and the towel heater) without exposure to the atmospheric effects.

** **OPEN HEATING SYSTEM:** It is a system that water circulates in the installation (including the radiator and the towel heater) being exposed to atmospheric

effects through open expansion tanks. Open expansion tanks are used in order to balance the increasing pressure or to compensate the diminishing water in the heating system.

*** **SANITARY HOT WATER SYSTEM:** Domestic hot water is used for domestic purposes as well as heating the radiators and towel warmers in an open circuit.

AFTER SALES SERVICES

If a manufacturing defect is observed within the warranty period, provided that it has been installed and operated in accordance with these instructions, we undertake first to repair the product. If the product can not be repaired, we offer to exchange (we keep the right to modify, change, revise or cancel the products in our range, so exchange is subjected to availability). If the product is no longer in our range, we offer a substitute product.

If this product appears damaged when first received or does not function correctly contact us by e-mail aftersales@hammamradiator.com.tr

To assist you, we will need the following information: model name & number (this can be found at the back of the product) nature of the fault & date of purchase. Please retain your receipt as proof of purchase.

NOTES FOR DISPOSAL OF THIS PRODUCT VALID FOR THE EUROPEAN UNION

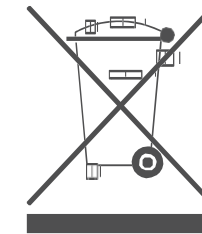

The crossed-out wheeled-bin symbol on your product reminds you that in the European Union all electrical and electronic products and batteries must be separately disposed at the end of their working life.

Do not dispose of these products as unsorted domestic waste. Return the products to

recycling to prevent possible harm to the environment or human health and to promote the sustainable reuse of material resources. Recycling information is available at the product retailer, local waste authorities or national organizations.

The producer is not liable for the misspellings and copying errors. The producer remains the right to make changes in the product. This document can not be copied completely or partially without the written permission of the producer.

For installation, please refer to the instruction manual which comes along with the product.

INSTALLATION GUIDE

TOOLS REQUIRED FOR INSTALLATION



ELECTRIC DRILL &
DRILL BIT



SPIRIT LEVEL



CORDLESS & CROSSPOINT
SCREWDRIVER (BIT PH2)



METRIC RULER



HAMMER



STEPLADDER
(FOR HIGH PRODUCTS)



ALLEN KEY

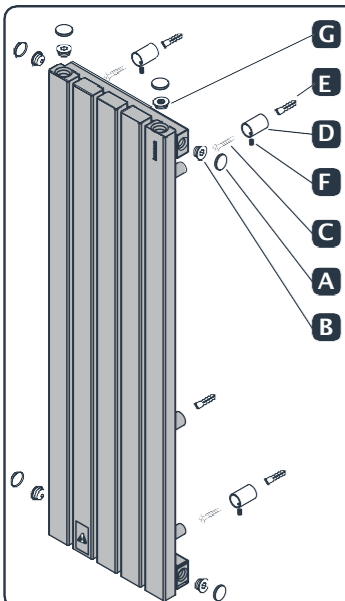

Installation information in this section includes below products!

ARES, NORTE, RAMSEY

CONTENT OF MOUNTING SET

Decorative Cap (x6)
Only for mirror finished products



Blind Plug (x5)



Wall Mounting Screw (x4)



Wall Mounting Bracket (x4)



Wall plug (x4)



Setscrew (x4)



Air Vent (x1)



Diverter (x1)



INSTALLATION

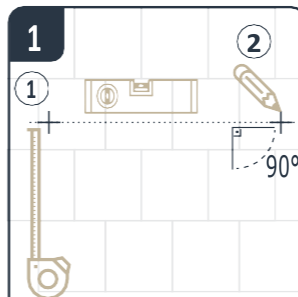

- 1- Adjust the height of your radiator by using a metric ruler.
- 2- Set the location of your radiator as desired, align with the ground by using a spirit level and mark the position of the wall mounting brackets.

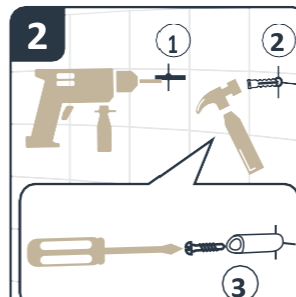

- 1- Drill holes (Ø 10 mm) into the spots you have marked.
- 2- Nail the wall plugs (E) in the holes by using a hammer.
- 3- Screw the wall mounting brackets all the way to the holes with the help of a screwdriver.

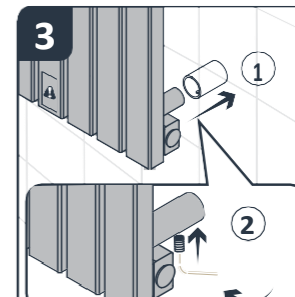

- 1- Place your radiator into the wall mounting brackets (D).
- 2- Insert the setscrews (F) into the slots on the mounting brackets (D), adjust the distance between the wall and your radiator then tighten the setscrews by using an Allen key (M3).

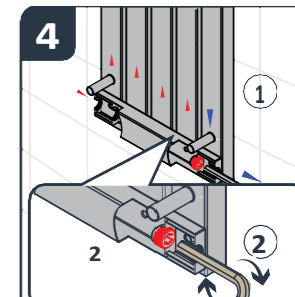

- 1- Insert the diverter into the tube where the outlet valve is located then push until it reaches the metal sheet inside the tube.
- 2- Screw the diverter onto the metal sheet by using an Allen Key (M10).

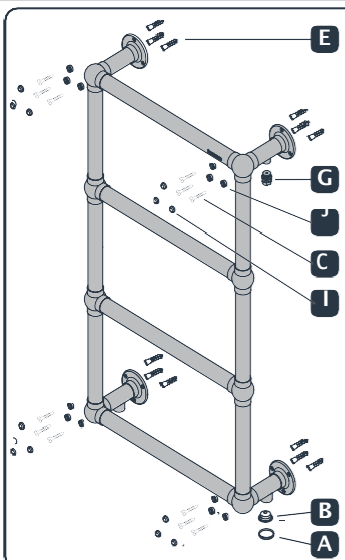

Installation information in this section includes below products!

BIANCA, UNO, MALIBU

CONTENT OF MOUNTING SET

Decorative Cap (x1)
Only for mirror finished products



Blind Plug (x1)



Wall Mounting Screw (x12)



Wall Plug (x12)

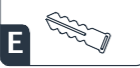

Air Vent (x1)



Screw Cap Holder (x12)



Screw cap (x12)



INSTALLATION

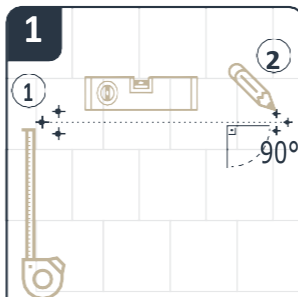

- 1- Adjust the height of your radiator by using a metric ruler.
- 2- Set the location of your radiator as desired, align with the ground by using a spirit level and mark the position of the wall mounting brackets.

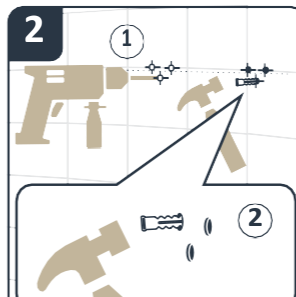

- 1- Drill holes (Ø 10 mm) into the spots you have marked.
- 2- Nail the wall plugs (E) in the holes by using a hammer.

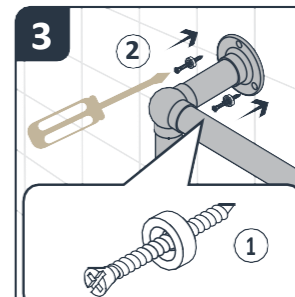

- 1- Pass the wall mounting screws (C) through the screw cap holders (J).
- 2- Place your radiator on the wall and screw the mounting brackets all the way into the wall with the help of a screwdriver.

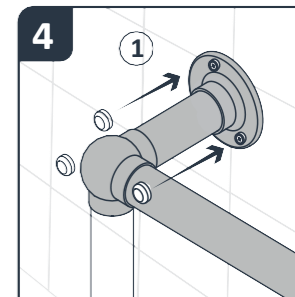

- 1- Attach the screw caps (I) to the screw cap holders (J) on the wall mounting brackets.



IMPORTANT NOTE

- Place your radiator at least 12.5 cm above the floor.
- Provide insulation by wrapping PTFE tape on the treads before installing the valves.
- Apply silicone seal fluid to all treaded parts containing o-rings.
- Connect your radiator to the utilities after following all the installation steps in the manual.
- After connecting to the utilities, do not forget to discharge the trapped air inside the radiator before commissioning.

TERMS AND CONDITIONS

You must immediately remove all packaging, inspect the goods and notify us of any damage to the goods within 3 days of delivery. We shall have no obligation to replace or repair damaged goods in the event of failure by the Buyer to comply with this provision. Radiators, which are off an unacceptable standard or are damaged, must not be installed. If any items is installed it will be treated as being as accepted as received.

Damaged goods being returned will only be collected from your delivery address, unless otherwise agreed in writing. Any other goods, which we accept back, are to be returned by you to our place of business at your expense.

Items will be accepted as a return, which have not been installed or damaged after delivery. We do not accept liability for any damages sustained after delivery. Goods should be returned in their original packaging, provided such packaging and goods are undamaged.

We may issue a credit note for goods, which we accept as returned.

We may agree to provide you with replacement goods prior to collecting or receiving back the goods to be returned (whether faulty, damaged or otherwise) but only on the condition that: the replacement goods are paid for in full and we reserve the right to re-invoice you in the event that the returned goods are found to be in a worse condition than when they were originally received by you or where such goods have not been received back to us within 3 months of the replacement goods being received by yourselves. A re-stocking charge of 30% will be applied to all non-faulty stock items that wish to be returned. Special order and non-stock products cannot be cancelled. Where cancellation or alteration of orders is accepted by us, you may be required to pay a restocking charge, to cover administrative costs and collection costs (if applicable); such charges to be determined by us. If the goods we deliver are faulty or damaged, we will meet the cost of the return, as long as the fault is reported to us within 3 working days.

The goods will be deemed to have been accepted when they have been delivered and we may not accept claims for any visible defects found after installation.

We accept no liability for any cost incurred relating to the cost of installation.

We shall not be liable for any plumber's costs, decorator's costs, transport costs, late penalties, or any other costs, as a direct or indirect result of (i) any defect in the goods (including but not limited to any manufacturing faults, such as leaks, that become apparent on or after installation) or (ii) late delivery of the goods.

GUARANTEES AND LIABILITIES – we are not the manufacturer of this product we will take all reasonable endeavours to make over to you the benefit of any warranty or guarantee given by the manufacturers. The item must have been fitted in accordance with British and or European standards as well as these fitting instructions.