

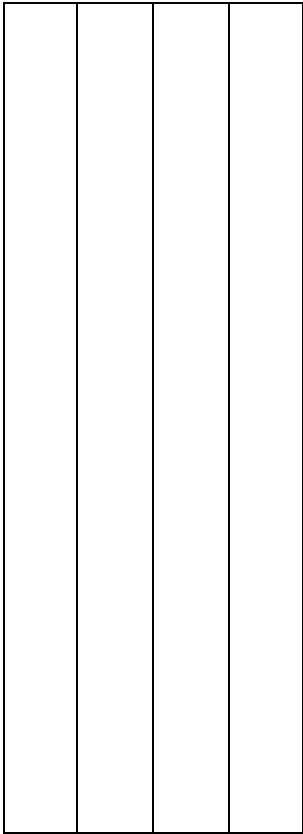

Moto Vertical Radiator Fixing Instructions

Please unpack your delivery carefully and inspect the radiator and contents – any damages or shortages must be notified to your supplier within 3 days of delivery of your goods.

SPECIFICATIONS FOR MOTO VERTICAL

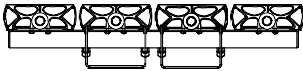

Technical Specifications

Materials	Aluminium
Connections	½" Flow and Return
Test Pressure	8 Bar
Testing Authority	EN442
Max operation pressure	4 Bar
Max working temperature	95c

These can be cleaned using a soft damp cloth with a non-abrasive cleaning product.

PLEASE NOTE: That in accordance with Part L1 2006 of the Building Regulations and BS7593:1992 code of practice for the treatment of hot water and central heating systems, we recommend flushing the heating system before installation of new radiators and then adding the correct quantity and type of inhibitor for use with the radiator and system to prevent corrosion. Damage caused to systems not protected by a suitable inhibitor will not be covered by the manufacturer warranty. It is the responsibility of the installer to ensure the correct use and suitability of the fixings provided. No liability for costs or damages arising from failure to do so can be accepted.



- ⚠ Do not remove the corner protectors and shrink until all the construction work is complete.
- ⚠ When connecting pipes of various materials, the difference in electrode potential may cause galvanic corrosion and serious damage. To avoid galvanic corrosion, it is highly recommended to use the same materials, or materials with similar electric potential, throughout loop.
- ⚠ The wall plugs supplied with your radiator may not be suitable for your wall type. The appropriate wall plugs should be used by your qualified installer.
- ⚠ Corrosion occurs on heating system components like radiator, valve, pump, etc. due to the oxygen diffusion through pipes, if the piping system is plastic. In such cases Oxygen barrier pipes should be used. Otherwise, radiators can be corroded and leaked.

Over - force should not be applied and pipe wrench should not be used during fixing. Specific care should be taken into consideration.

Do not apply force exceeding 18 Nm.

Liquid tread sealant should be used instead of PTFE tape or hemp.

Ph value of the water used in the system should be between 7,8 and 8,5.

REQUIRED MATERIALS FOR INSTALLATION

<p>Electric Drill , Drill Bit Ø10</p>	<p>Hammer</p>	<p>Metric Ruler</p>	<p>Spirit Level</p>	<p>Cordless Screwdriver (Bit PH2)</p>	<p>Cross Point Screwdriver</p>	<p>Spanner (8mm)</p>	<p>Stepladder (For high products)</p>
---	---------------	---------------------	---------------------	---	------------------------------------	--------------------------	---

CONTENT OF INSTALLATION SET

<p>Bracket</p> <p>x4</p>	<p>Bracket lock</p> <p>x4</p>	<p>6,3x60mm Screw</p> <p>x4</p>	<p>10 x 50 mm Wall Plug</p> <p>x4</p>	<p>Diverter</p> <p>x1</p>	<p>Air vent</p> <p>x1</p>	<p>Blind plug</p> <p>x1</p>	<p>Diverter fit-in plastic tube</p> <p>x1</p>	<p>Mounting bracket support part</p> <p>x8</p>
--------------------------	-------------------------------	-------------------------------------	---	---------------------------	---------------------------	-----------------------------	---	--

DIMENSIONS

Side view

Rear view

Width : W
Height : H
Distance between bracket center : X (Applicable for Tempo valves. For other valves "+90mm" measure will vary)
Distance between top and bottom bracket center : Y

⚠ Products with 3 sections

Total of 2 brackets needed on (One to the bottom collector and one to the top collector).

Rear view of 3 sections radiators

M-1

M-1
Mark the bracket holes of the product by measuring them according to the X, Y, Z dimensions.

M-2

M-2
Tighten all brackets from the point you marked by synchronizing with a spirit level.

M-3

M-3
Attach the plastic bracket supports to grooves on the brackets.

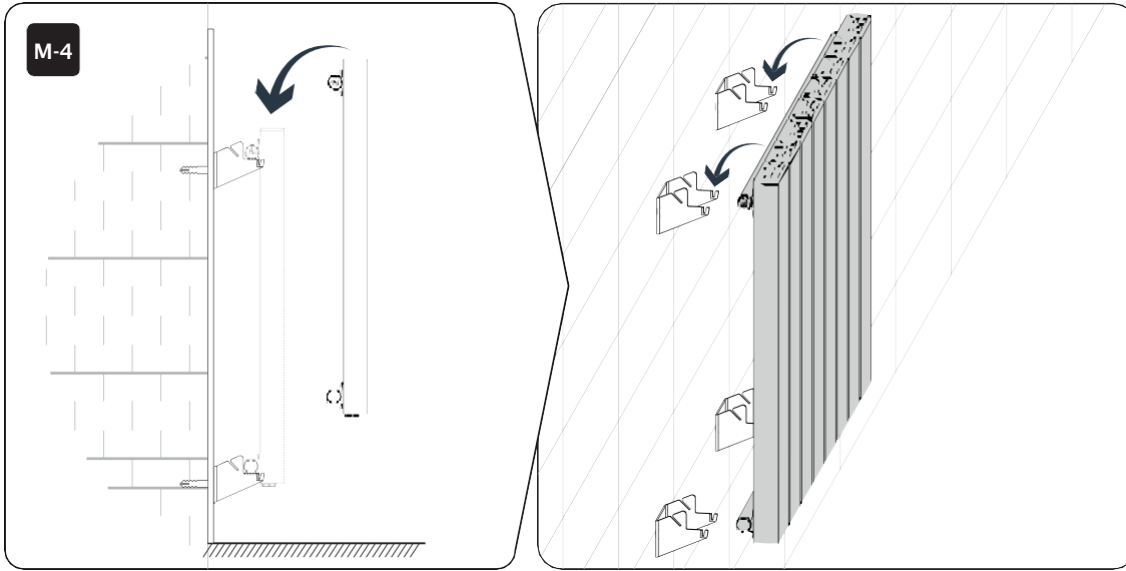

M-4
Position the product on the brackets so that the collectors pass through the channel on the brackets.

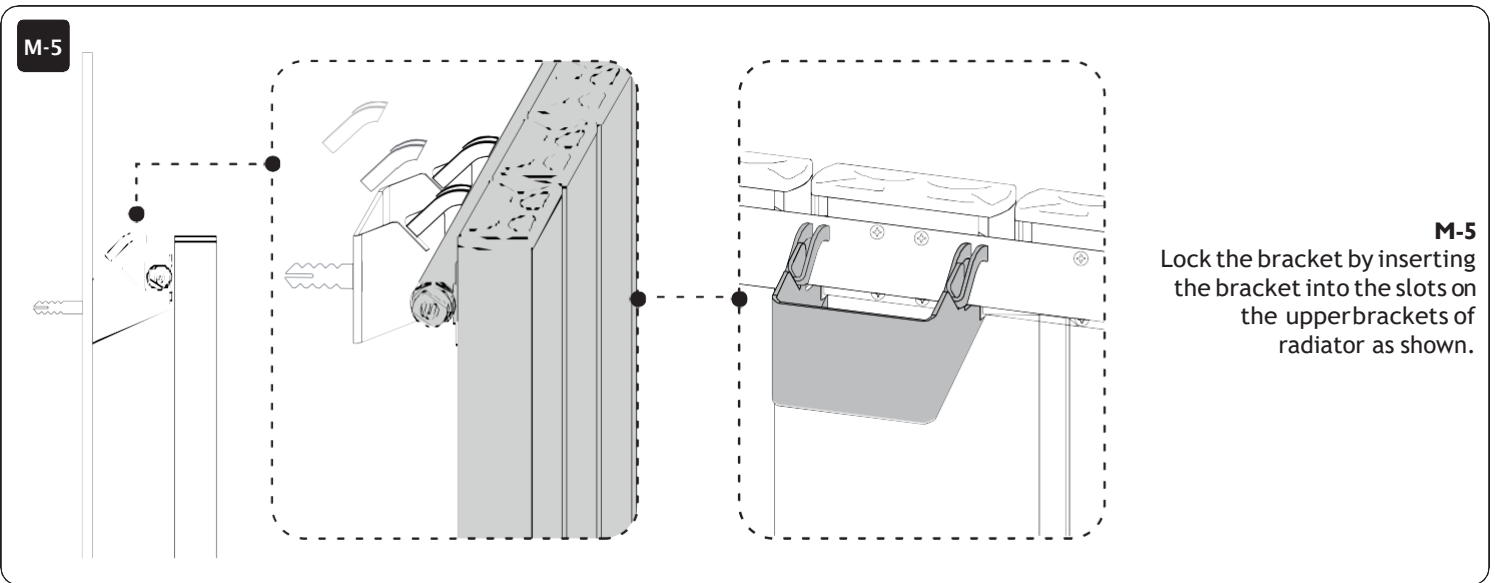

M-5
Lock the bracket by inserting the bracket into the slots on the upper brackets of radiator as shown.

Compact valve connection:
Please note this section if your radiator has a compact valve.



NOTE: If your product is equipped with a compact valve, there are 2 conduit couplings in addition to the contents.

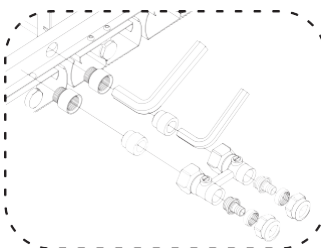

50 mm axis H valve assembly sequence

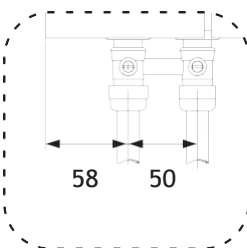

Compact Connection



C-1
Do not use linen or teflon as the sealing element while mounting the connection fittings.

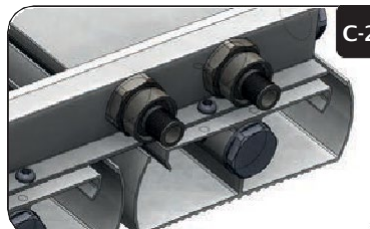

C-2
Do not apply more than 18 Newton meters.
** Do not use the pipe wrench, it may damage the product and apparatus.*

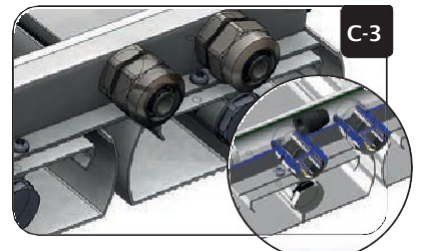

C-3
After the installation, apply force to the nuts. Do not exceed 18 Nm.

Thermostatic sensor installation:
Please note this section if your radiator has a thermostatic sensor.



T-1
If thermostatic sensor is not used, thermostatic core cover can also be used for valve purposes.



T-2
Pull out the thermostatic core cover which comes with the product.

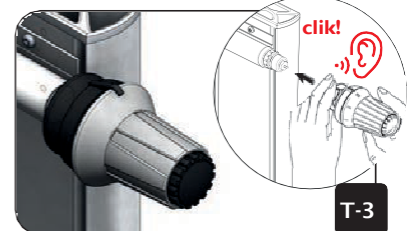

T-3
Before mounting the sensor, make sure that the adjustment mark on the sensor is placed above the sensor. Mount the thermostatic sensor on the valve and press in the direction of the arrow until you hear a clik.

TERMS AND CONDITIONS

You must immediately remove all packaging, inspect the goods and notify us of any damage to the goods within 3 days of delivery. We shall have no obligation to replace or repair damaged goods in the event of failure by the Buyer to comply with this provision. Radiators which are off an unacceptable standard or are damaged must not be installed. If any items is installed it will be treated as being as accepted as received.

Damaged goods being returned will only be collected from your delivery address, unless otherwise agreed in writing. Any other goods, which we accept back, are to be returned by you to our place of business at your expense.

Items will be accepted as a return which have not been installed or damaged after delivery. We do not accept liability for any damages sustained after delivery. Goods should be returned in their original packaging, provided such packaging and goods are undamaged.

We may issue a credit note for goods which we accept as returned.

We may agree to provide you with replacement goods prior to collecting or receiving back the goods to be returned (whether faulty, damaged or otherwise) but only on the condition that: the replacement goods are paid for in full and we reserve the right to re-invoice you in the event that the returned goods are found to be in a worse condition than when they were originally received by you or where such goods have not been received back to us within 3 months of the replacement goods being received by yourselves. A re-stocking charge of 30% will be applied to all non-faulty stock items that wish to be returned. Special order and non-stock products cannot be canceled. Where cancellation or alteration of orders is accepted by us, you may be required to pay a restocking charge, to cover administrative costs and collection costs (if applicable); such charges to be determined by us. If the goods we deliver are faulty or damaged, we will meet the cost of the return, as long as the fault is reported to us within 3 working days.

The goods will be deemed to have been accepted when they have been delivered and we may not accept claims for any visible defects found after installation.

We accept no liability for any cost incurred relating to the cost of installation.

We shall not be liable for any plumber's costs, decorator's costs, transport costs, late penalties, or any other costs, as a direct or indirect result of (i) any defect in the goods (including but not limited to any manufacturing faults, such as leaks, that become apparent on or after installation) or (ii) late delivery of the goods.

GUARANTEES AND LIABILITIES – we are not the manufacturer of this product we will take all reasonable endeavors to make over to you the benefit of any warranty or guarantee given by the manufacturers. The item must have been fitted in accordance with British and or European standards as well as these fitting instructions.